

Midway: Laboratory Worktops

Architects
Data File

Product Detail



Product: Midway
Code: LWT1560F

Issue: 1
Date: 07-09-16

Product description:

The Midway worktops are manufactured from 316 grade stainless steel to provide excellent acid and chemical resistance. These products are ideal for use in laboratories, kitchens, hospitals, canteens, clinics, residential homes and universities. This is just a small selection of what can be made in laboratory worktops. Other bespoke 316 grade sizes from single units to large layouts can be quoted on request. Image shown has a void stand, bracket and stands can be supplied on request. Upstanding and turn down size can be made to suit project requirements. All stands are manufactured from 304 grade stainless steel.

Product: Code:

Wall Table

Midway	LWT0660F
Midway	LWT0960F
Midway	LWT1260F
Midway	LWT1560F
Midway	LWT1860F

Technical Detail:

Material:	<316>	1.4401	Table
Material:	<304>	1.4301	Frame & Shelf
Finish:	Satin Polished		
Gauge:	1.2mm		
Earth Tag:	Yes		

WALL TABLES
60mm Upstand / 60mm Down Turn

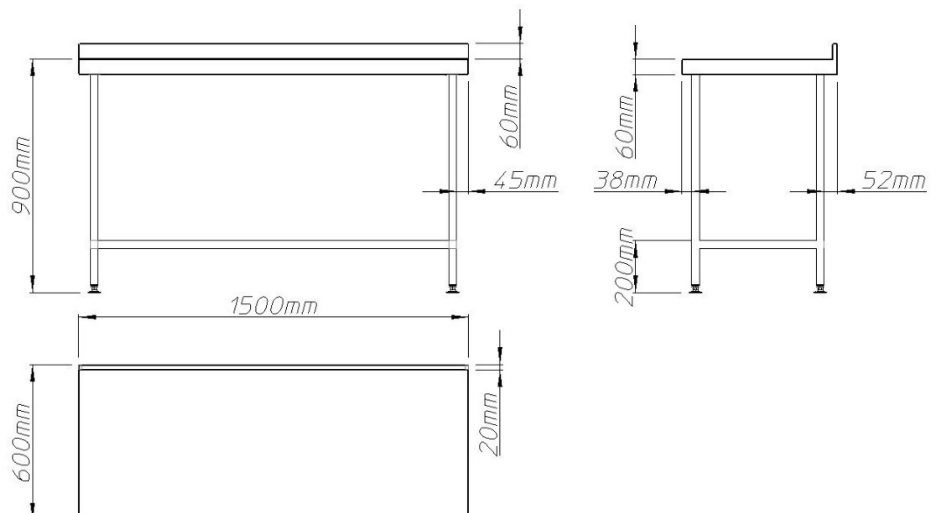

Care Of Your Product

HANDLING AND FIXING CAUTION

Take care when handling and fixing this product. Exposed edges of the stainless steel, including tap holes, upstand, overflows and wastes etc. may cause harm if handled without due caution. When using the fixing clips supplied with inset sinks avoid touching the two prongs on the area of the clip that grips the underside of the worktop.

TO THE STOCKIST

Please store products in a cool, dry area.

Sinks should, where possible be stood on their ends supported by battens with the bowl uppermost.

If sinks are nested with bowls inside one another, place some dry cushioning material between them to protect the surfaces.

TO THE INSTALLER

DO handle with care to avoid scuffs and scratches during installation.

DO check that edges of sinks are dead level so that water will flow off the draining board.

DO NOT over-tighten plumbing or other mechanical fixtures.

DO NOT remove the plastic protective film applied to certain products until all installation work has been completed.

DO NOT stand/kneel on the drainer of sinks.

DO NOT drop mortar, plaster or similar substances onto the stainless steel.

TO THE USER

Stainless steel will give you a lifetime of trouble free use as long as you follow a few simple rules. If it appears to mark, don't worry, it is usually not the steel, but something deposited on it, which has caused the apparent stain.

DO - wash the product before use.

DO - clean the product regularly, using JIF, Goddard's, or similar recommended cleaners. Follow the manufacturer's instructions carefully. Always rinse well with clean water and dry the surface with a soft cloth.

DO - use nylon or bristle brushes, not metal scrapers or wire brushes to loosen stubborn stains.

Never use wire wool pads, as they can scratch the steel.

DO - take care when handling sharp objects as they can scratch the surface of the steel. Any scratches will blend together over a period of time and become less noticeable with age. There is no detriment to the corrosion resistance or general performance of the material.

DO NOT - allow undiluted bleach to remain in contact with stainless steel (remember dishwasher powders, sterilising agents and similar products all contain chlorides). Black pit marks can result and permanent damage can be caused. Dilute to manufacturer's instructions and always rinse with clean water.

DO NOT - soak clothes in bleach solutions for long periods. Always rinse bowl with clean water after use.

DO NOT - leave such substances as Mortar, Grouting cement, soldering flux, photographic developing fluids, silver dip, denture liquids or food acids on the surface of the steel. Clean immediately and rinse well with clean water.

DO NOT - allow corrosive foodstuffs, such as fruit juices, damp salt, vinegar, mustards, pickles and mayonnaise to remain on the surface of the steel for long periods. Wash and rinse away.

DO NOT - let hard water cause a build-up of lime or chalk deposits which can sometimes be seen as a greyish film. Clean regularly with recommended cleaners to avoid this problem and always wipe dry with a soft cloth.

DO NOT - worry if the steel appears to rust. Usually it's deposits of wire wool scouring pads, plumbers swarf, particles from rusting storage tanks or other deposits on the surface which can be cleaned and rinsed away following your usual cleaning procedure. Bases of washing up bowls can harbour such deposits – check regularly.

DO NOT - use coarse grit cleaners or wire wool pads when cleaning the steel. They will scratch the surface.

DO NOT - leave carbon steel objects such as bottle openers, scissors, whisks and other kitchen objects standing on the surface for long periods, they can rust and leave marks.

DO PLEASE ENJOY YOUR NEW STAINLESS STEEL PRODUCT

Cleaning Regime

Problem

Routine Cleaning.

Oil & Grease Marks.

Stubborn marks, stains and light discoloration.

Heavy discoloration or heat tint.

Lime Scale

Corrective Treatment

Washing up liquid, all-purpose cleaning liquid, swab with cloth or sponge rinse well.

Degreasing fluid or cellulose thinners.

Mild abrasive creams (Sif / Shiny sinks).

Use metal polish (Brasso, Goddard's S/S Cleaner, Bar Keepers Friend) or a light non-metallic abrasive pad. Dura glit.

Apply descaler as instructed, agitate & allow to soak, re apply if not fully removed.
(Met-soak DX4920 or Hi-Phos)

Comments

Satisfactory on all surfaces.

Rinse with soap & water.

Heavy stains can be loosened by soaking with Metsoak or Hi-Phos. Rinse thoroughly after soaking as these products cause rust type marks if left.

Use only on grain finish surfaces and work in direction of grain as slight scratching will occur.

Bleach solutions including over the counter brands must only be used in dilution as instructed and thoroughly rinse immediately after application as chloride containing compounds will cause corrosion on all grades of stainless steel.

Rinse thoroughly after application and wipe dry as rust type stains can result if left undiluted on surface