

Pland for Laboratory

CI/SfB

January 2015

(7-)

h3

Uniclass L721/L83/L852



Pland















Strength in stainless steel

For more information
or to order please call
0113 2634184
or visit our website
www.plandstainless.co.uk

**Beautifully
designed
stainless
steel for
every
application**

Product Features Key

Product feature icons - The following icons give information about individual product specifications.

	304 Grade Stainless Steel		0.7mm Steel Thickness
	316 Grade Stainless Steel		0.8mm Steel Thickness
	Healthcare Compliant		0.9mm Steel Thickness
	Satin Finish		1.0mm Steel Thickness
	Polished Finish		1.2mm Steel Thickness
	Water Regulation Approved		1.5mm Steel Thickness
	Sensor Operated		2.0mm Steel Thickness
			3.0mm Steel Thickness

Laboratory



Stainless steel is ideal for applications in medical, scientific, industrial, and commercial laboratories. For many research establishments corrosion resistance and durability are important benefits, whilst in some scientific contexts its non-magnetic properties will be of primary importance.

In all laboratory installations, stainless steel products bring the valuable characteristics of being impervious to most chemicals, easy to clean and of great strength whilst having an aesthetic appearance appropriate to scientific installations.

All Pland laboratory sinks and tables are manufactured with 316 grade stainless steel for improved corrosion resistance.

Troy - Sit-on sink tops

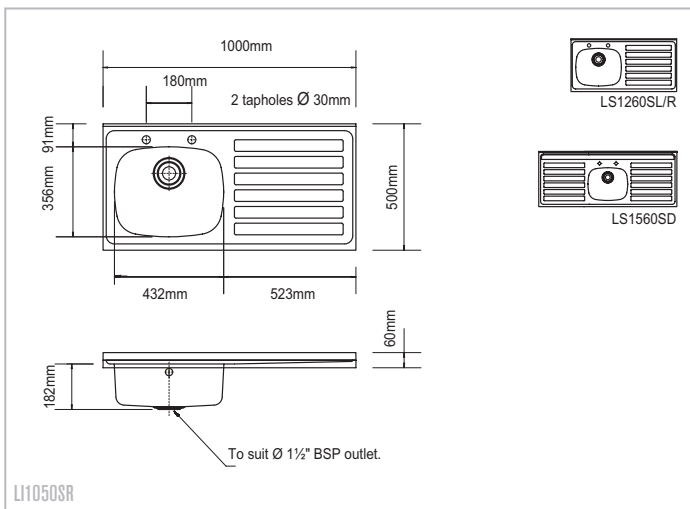

Sit-on sink tops manufactured in polished 1.4401 (316) grade stainless steel to provide excellent acid and chemical resistance. These products are ideal for use in laboratories, kitchens, hospitals, canteens, clinics, residential homes and universities. Supplied with tap holes at 180mm centres, 29mm overflow, sound deadening pads, fixing clips (where appropriate) and integral earth tag. Sit-on models incorporate safety return fold on front edge and 30mm up stand and turndown. Available without overflow on request. Bespoke 316 grade products can be quoted on request.

Product	Code
Troy sit-on sink	
1000mm x 500mm single bowl, single drainer, bowl 432mm x 356mm x 180mm	LS1050SL/R
1000mm x 600mm single bowl, single drainer, bowl 432mm x 356mm x 180mm	LS1060SL/R
1200mm x 600mm single bowl, single drainer, bowl 432mm x 356mm x 180mm	LS1260SL/R
1500mm x 600mm single bowl, double drainer, bowl 432mm x 356mm x 180mm	LS1560SD
Options	
1 1/2" bsp acid resistant waste and overflow	WAC00100

Troy - Inset sink tops



LI0952SR

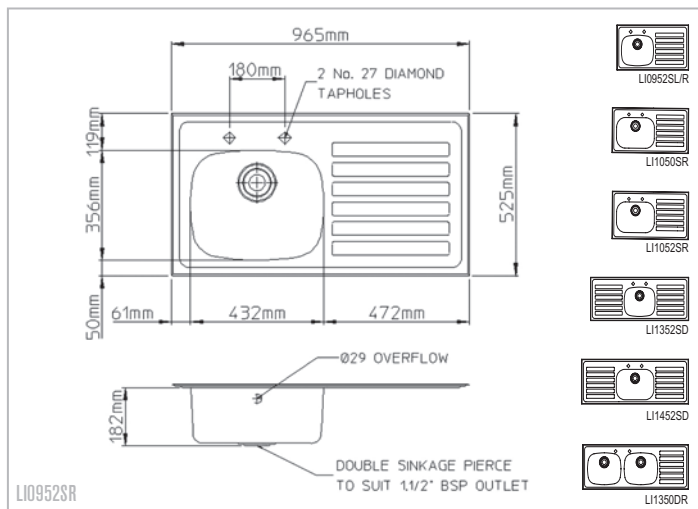

LI0952SR

Inset sink tops manufactured in polished 1.4401 (316) grade stainless steel to provide excellent acid and chemical resistance. These products are ideal for use in laboratories, kitchens, hospitals, canteens, clinics, residential homes and universities. Supplied with tap holes at 180mm centres, 29mm overflow, sound deadening pads, fixing clips (where appropriate) and integral earth tag. Available without overflow on request. Bespoke 316 grade products can be quoted on request.

Product

Code

Troy inset sink

965mm x 525mm single bowl, single drainer, bowl size 432mm x 356mm x 180mm	LI0952SL/R
1028mm x 500mm single bowl, single drainer, bowl size 508mm x 356mm x 250mm	LI1050SL/R
1028mm x 525mm single bowl, single drainer, bowl 508mm x 356mm x 250mm	LI1052SL/R
1376mm x 525mm single bowl, double drainer, bowl size 432mm x 356mm x 180mm	LI1352SD
1448mm x 525mm single bowl, double drainer, bowl size 508mm x 356mm x 250mm	LI1452SD
1364mm x 500mm double bowl, single drainer, bowl size 432mm x 356mm x 180mm	LI1350DL/R

Options

1 1/2" bsp acid resistant waste and overflow	WAC00100
Unslotted 1 1/2" bsp upstanding tubular overflow and waste	CATU12

Midway - Laboratory worktops



LWT1860

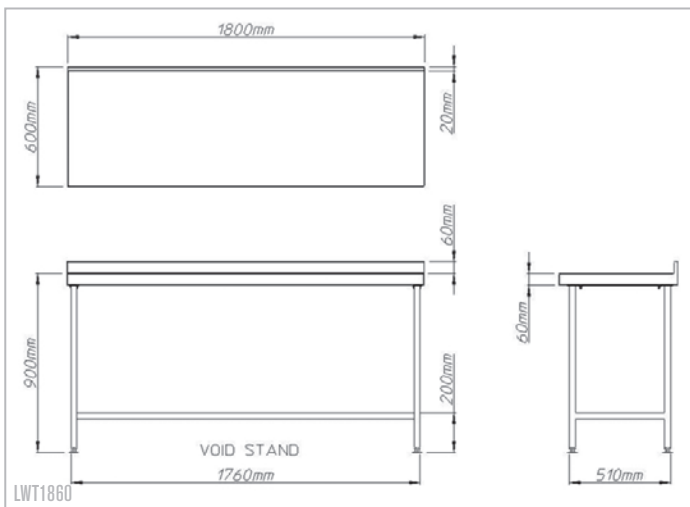

LWT1860

The Midway worktops are manufactured from 316 grade stainless steel to provide excellent acid and chemical resistance. These products are ideal for use in laboratories, kitchens, hospitals, canteens, clinics, residential homes and universities. This is just a small selection of what can be made in laboratory worktops. Other bespoke 316 grade sizes from single units to large layouts can be quoted on request. Image shown has a void stands, bracket and stands can be supplied on request. Upstanding and turn down size can be made to suit project requirements. All stands are manufactured from 304 grade stainless steel.

Product

Code

Midway wall table

600mm X 600mm	LWT0660F
900mm X 600mm	LWT0960F
1200mm X 600mm	LWT1260F
1500mm X 600mm	LWT1560F
1800mm X 600mm	LWT1860F

Midway island table

600mm X 600mm	LIT0660F
900mm X 600mm	LIT0960F
1200mm X 600mm	LIT1260F
1500mm X 600mm	LIT1560F
1800mm X 600mm	LIT1860F

Syracuse - Oval bowl



IOMOS09SR

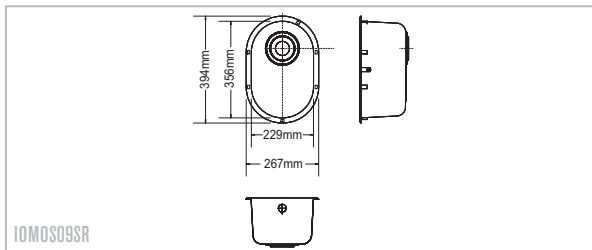

IOMOS09SR

Syracuse oval bowls in 316 (1.4401) grade stainless steel offer excellent acid and chemical resistance. Available as inset and flat flange models, they are supplied with sound deadening pads and integral earth tag to BS 4190. Bespoke size 316 fabricated bowls can be made on request.

Product

Code

Syracuse inset bowl

229mm x 356mm x 180mm

IOMOS09SR

Syracuse flat flange bowl

229mm x 356mm x 180mm

IOMOS09FF

Options

1 1/2" bsp acid resistant waste and overflow

WAC00100

Unslotted 1 1/2" bsp upstanding tubular overflow and waste

CATU12

Babylon - Quartic bowl



IOMOS107SR

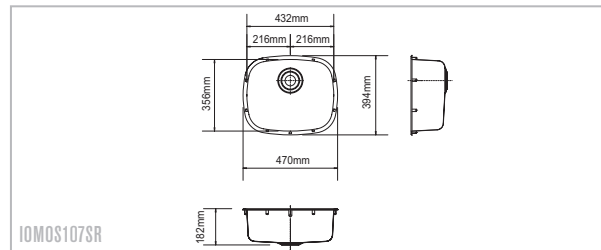

IOMOS107SR

Babylon quartic bowls in 316 (1.4401) grade stainless steel offer excellent acid and chemical resistance. They are supplied with sound deadening pads and integral earth tag to BS 4190. Bespoke size 316 fabricated bowls can be made on request.

Product

Code

Babylon inset bowl

432mm x 356mm x 180mm

IOMOS107SR

Babylon flat flange bowl

432mm x 356mm x 180mm

IOMOS107FF

Options

1 1/2" bsp acid resistant waste and overflow

WAC00100

Unslotted 1 1/2" bsp upstanding tubular overflow and waste

CATU12

Sparta - Rectangular inset bowl



IOMOS210SR

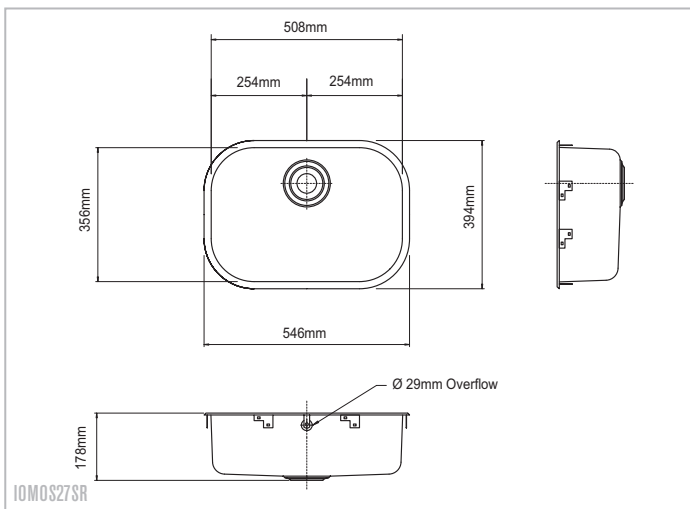

Sparta inset rectangular bowls are manufactured in 1.4401 (316) grade stainless steel which offers excellent acid and chemical resistance. Sparta bowls are regularly specified for use in laboratories, kitchens, hospitals, canteens, clinics, residential homes and universities. Sparta inset bowls are supplied with sound deadening pads and integral earth tag to BS 4190. Available without overflow on request. Bespoke size 316 fabricated bowls can be made on request.

Product	Code
---------	------

Sparta inset bowls

305mm x 356mm x 160mm	IOMOS12SR
508mm x 356mm x 180mm	IOMOS27SR
508mm x 356mm x 250mm	IOMOS210SR
533mm x 381mm x 200mm	IOMOS38SR
533mm x 381mm x 250mm	IOMOS3810SR
610mm x 457mm x 305mm	IOMO412SR

Options

1 ½" bsp acid resistant waste and overflow	WAC00100
IOMO412SR requires overflow tube and waste	CATU12

Sparta - Rectangular flat flange bowl



IOMOS38FF

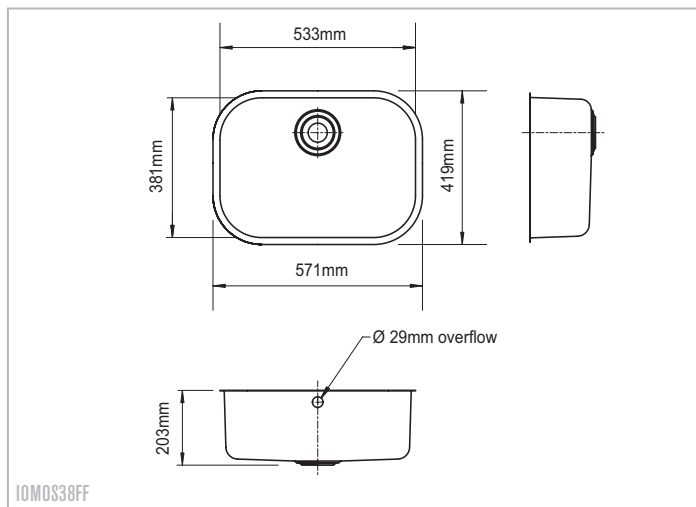

IOMOS38FF

Sparta rectangular flat flange bowls are manufactured in 1.4401 (316) grade stainless steel which offers excellent acid and chemical resistance. Sparta bowls are regularly specified for use in laboratories, kitchens, hospitals, canteens, clinics, residential homes and universities. Sparta rectangular flat flange bowls are supplied with sound deadening pads and integral earth tag to BS 4190. Available without overflow on request. Bespoke size 316 fabricated bowls can be made on request.

Product

Code

Sparta flat flange bowls

305mm x 356mm x 160mm
 508mm x 356mm x 180mm
 508mm x 356mm x 250mm
 533mm x 381mm x 200mm
 533mm x 381mm x 250mm
 610mm x 457mm x 305mm

IOMOS12FF
 IOMOS27FF
 IOMOS210FF
 IOMOS38FF
 IOMOS3810FF
 IOMO412FF

Options

1 1/2" bsp acid resistant waste and overflow
 IOMO412FF requires overflow tube and waste

WAC00100
 CATU12

Dion - Lab tap



TP1134

WHITE

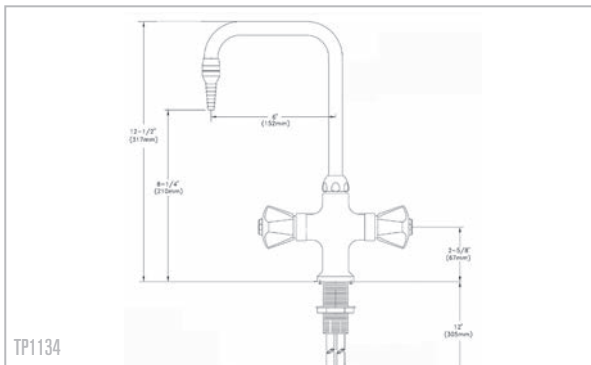

TP1134

Laboratory mixer tap, white deck mounted with 6" rigid/swing goose neck. Moulded nylon handle green coded per Din. Standard.

Product

Code

Dion laboratory mixer tap

White deck mounted 6" rigid/swing goose neck

TP1134

Assur - Lab tap



TP1135

WHITE

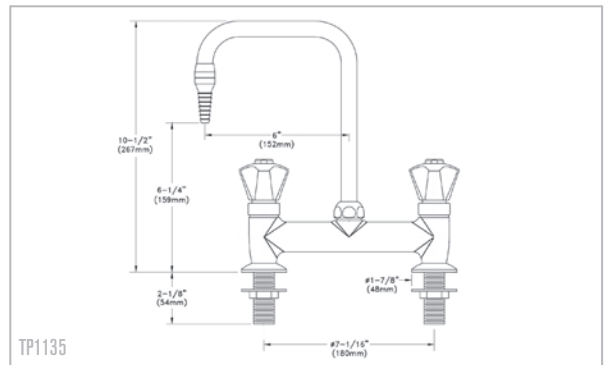

TP1135

Laboratory bridge mixer tap, white deck mounted with 6" rigid/swing goose neck. Moulded nylon handle green coded per Din. Standard.

Product

Code

Assur laboratory mixer tap

White bridge mixer tap 6" rigid/swing goose neck.

TP1135

Actium - Lab tap



TP1130

NICKEL

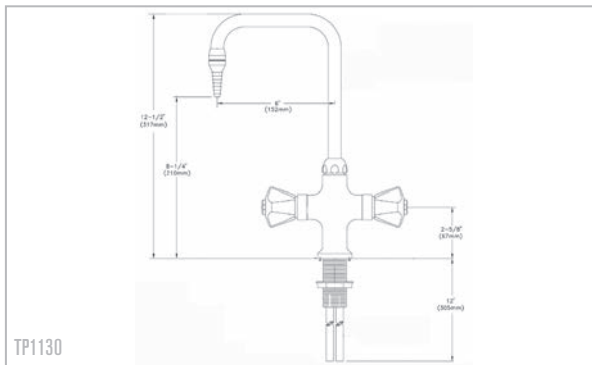

TP1130

Laboratory mixer tap, nickel deck mounted with 6" rigid/swing goose neck. Moulded nylon handle green coded per Din. Standard.

Product

Code

Actium laboratory mixer tap

Nickel deck mounted 6" rigid/swing goose neck

TP1130

Adana - Lab tap



TP1131

NICKEL

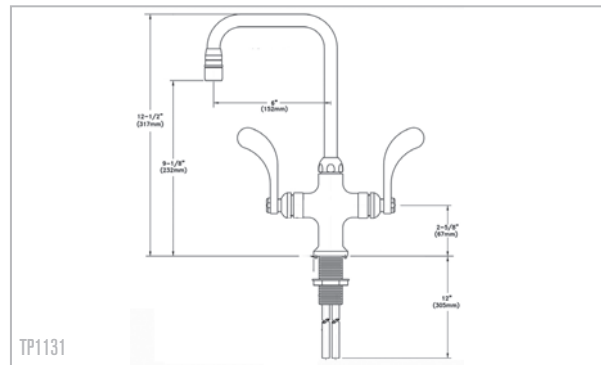

TP1131

Laboratory mixer tap, nickel deck mounted with 6" rigid/swing goose neck. Wrist lever operated with aerator.

Product

Code

Adana laboratory mixer tap

Deck mounted 6" rigid/swing goose neck.

TP1131

Kourium - Lab tap



TP1132

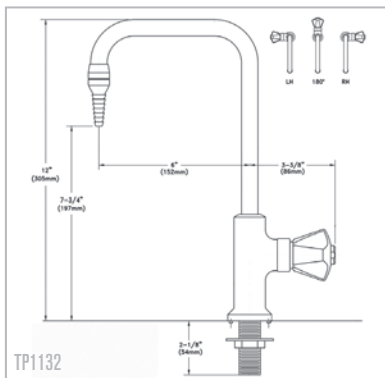

TP1132

Laboratory single tap, deck mounted with 6" goose neck moulded nylon hooded handle.

Product

Code

Kourium laboratory tap

Deck mounted 6" rigid/swing goose neck. TP1132

Alexandria - Lab tap



TP1133

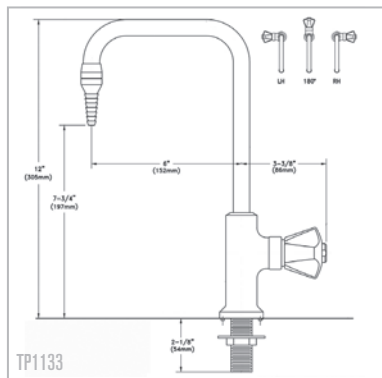

TP1133

Laboratory single nickel tap, deck mounted with 6" goose neck moulded nylon hooded handle.

Product

Code

Alexandria laboratory nickel tap

Deck mounted 6" rigid/swing goose neck. TP1133

Sura - Lab tap



TP1128

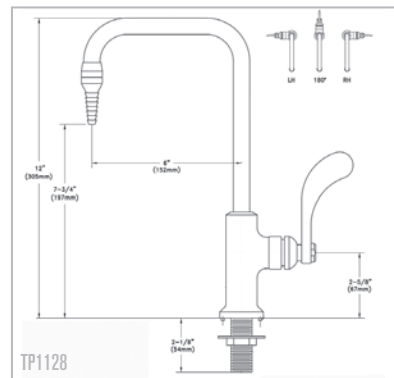

TP1128

Laboratory single tap, white tap deck mounted with 6" goose neck wrist lever operated with aerator.

Product

Code

Sura laboratory single tap

White deck mounted 6" goose neck lever operated

TP1128



Other Pland Products

You may also be interested in our other specialist sectors

We offer a wide range of stainless steel products for many other industries.

Call now for a specific brochure or to receive our full Compendium - **0113 2634184**

alternatively visit our website to view or download product details - **www.plandstainless.co.uk**



Catering



Janitorial



Washroom



Education



Laboratory



Sanitaryware



Healthcare



Secure



Bespoke

Pland Stainless Limited, Lower Wortley Ring Road, Leeds, West Yorkshire, LS12 6AA

Telephone 0113 263 4184 Fax 0113 231 0560 www.plandstainless.co.uk sales@plandstainless.co.uk

All rights reserved. Other than for creating architectural and design specifications and construction design proposals, no part of this publication may be reproduced in any material form including photocopying or storing in any medium by electronic means without the written permission of the copyright holder. At Pland we continually update and develop our products and therefore reserve the right to make changes to the products described without notice. E & OE.

© Pland Stainless Limited 2015

Written and designed by 9y Creative Communications www.9ycreative.co.uk

Artwork and printing by Briggs Brothers Colour Printers www.briggsbros.com